



## 48" Round Dining Table Assembly Instructions

**IMPORTANT : PLEASE READ COMPLETE INSTRUCTION SHEET PRIOR TO ASSEMBLY!**  
 Identify all parts packed in carton against the parts list. Remove all protective materials, place parts on a nonabrasive surface to avoid scratching. If any parts are missing or damaged, DO NOT attempt to assemble.

**Step 1:** Place legs on a flat, soft surface, insert leg B into leg A.







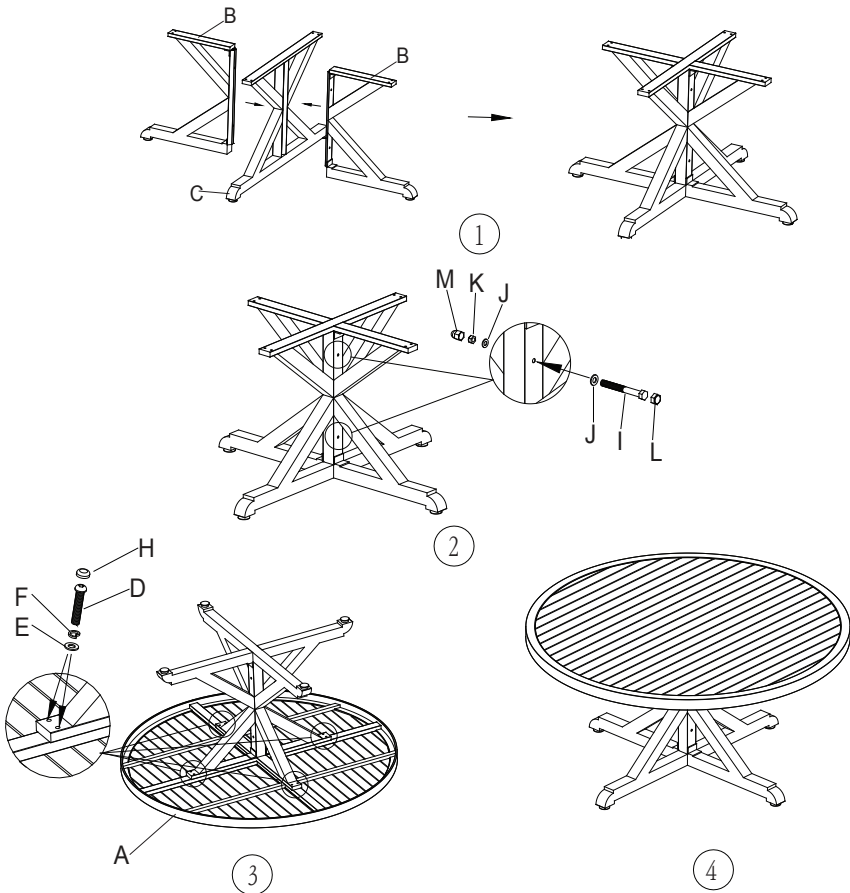



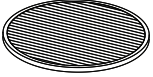
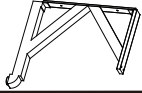
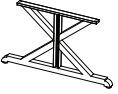

**Step 2:** Attach legs A and B with supplied bolts and metal washers and nuts.

**Step 3:** Place table top upside down on a flat, soft surface. Attach legs with supplied bolts and lock washers and metal washers.

**Step 4:** Tighten all bolts. Cover all bolts with plastic bolt caps.  
 Turn the table in the upright position. Your table is now ready for use.



## PARTS LIST

A	TABLE TOP		1
B	TABLE LEG 1		2
C	TABLE LEG 2		1
D	BOLT(M6*40)		8
E	METAL WASHER(M6)		8
F	LOCK WASHER(M6)		8
G	ALLEN WRENCH		1
H	PLASTIC BOLT CAP(M6)		8
I	BOLT(M8*70)		2
J	METAL WASHER(M8)		4
K	NUT(M8)		2
L	PLASTIC BOLT CAP(M8)		2
M	PLASTIC NUT CAP(M8)		2
N	HEX WRENCH		2